

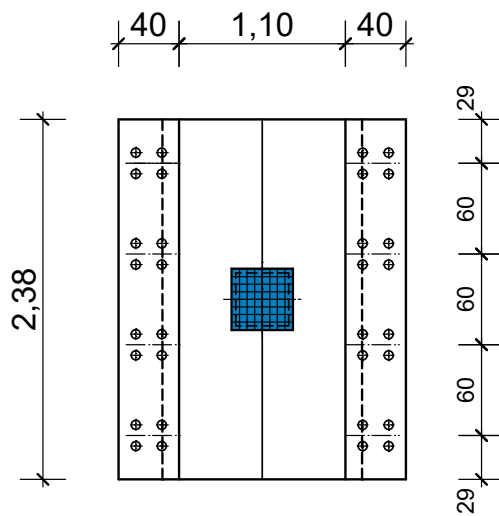

WIDOK Z GÓRY

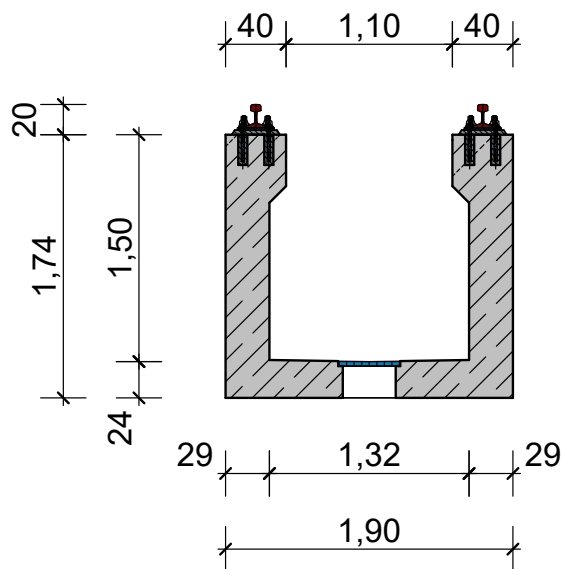

PRZEKRÓJ



Bauteil AG 238x110x150-1435-AP 49E1 / 60E1	Maßstab 1 : 50	Blatt-Nr. - 6	Index -	
Planersteller  BETONFERTIGTEILE B+F Beton- und Fertigteilegesellschaft mbH Lauchhammer Bockwitzer Straße 85, 01979 Lauchhammer Telefon: +49 (0) 35 74 78 04-0 E-Mail: info@bfi-gmbh.de Fax: +49 (0) 35 74 28 20 Internet: www.bfi-gmbh.de	Datum gezeichnet 06.12.2023	Name Kettner		
	geprüft			Schutzvermerk ISO 16016 beachten.
	Blatt-Abmessungen: A4 / 21.0 x 29.7 cm			