

WIDOK Z GÓRY

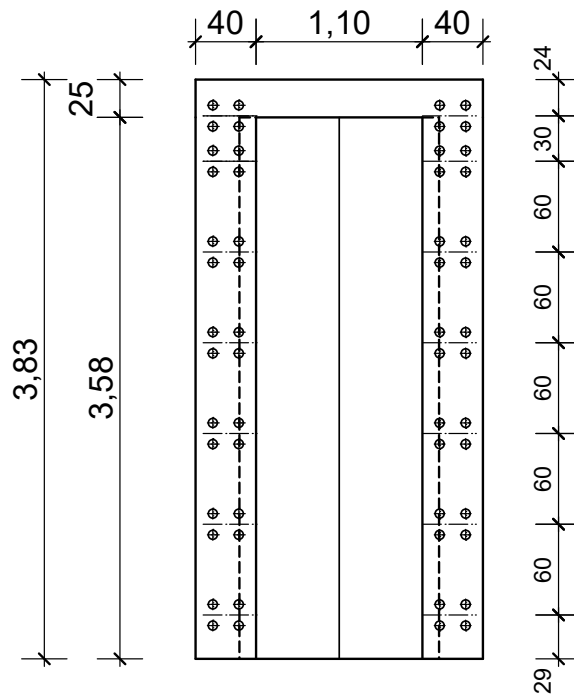

PRZEKRÓJ

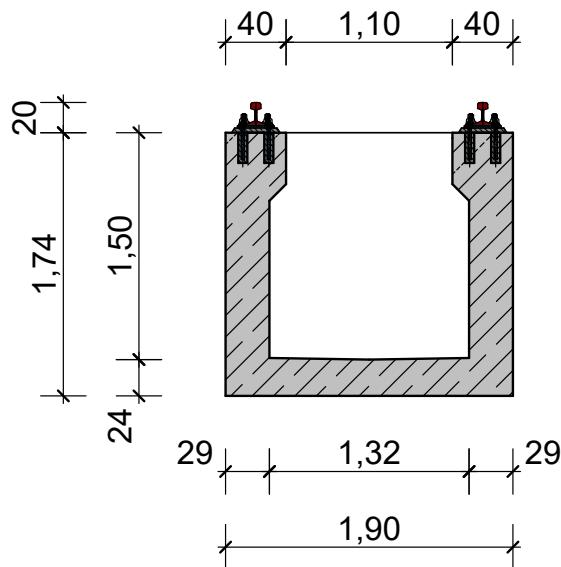

Bauteil AG 358x110x150-1435-AS 49E1 / 60E1	Maßstab 1 : 50	Blatt-Nr. - 7	Index -	
Planersteller  BETONFERTIGTEILE B+F Beton- und Fertigteilegesellschaft mbH Lauchhammer Bockwitzer Straße 85, 01979 Lauchhammer Telefon: +49 (0) 35 74 78 04-0 E-Mail: info@bfl-gmbh.de Fax: +49 (0) 35 74 28 20 Internet: www.bfl-gmbh.de	Datum	Name		
	gezeichnet	06.12.2023	Kettner	
	geprüft	Schutzvermerk ISO 16016 beachten.		
Blatt-Abmessungen: A4 / 21.0 x 29.7 cm	Datei: D:\DICAD\katalog AG \ AG-358x110x150-1435-AS-S49.kon			